

# Telemetry Application Examples

## MT32-Railway

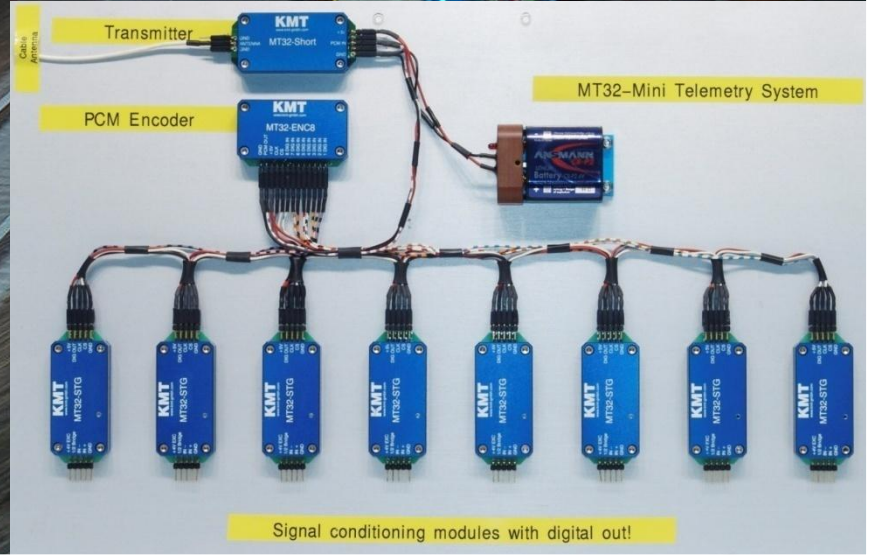

# Telemetry Application Examples

## MT32-Railway

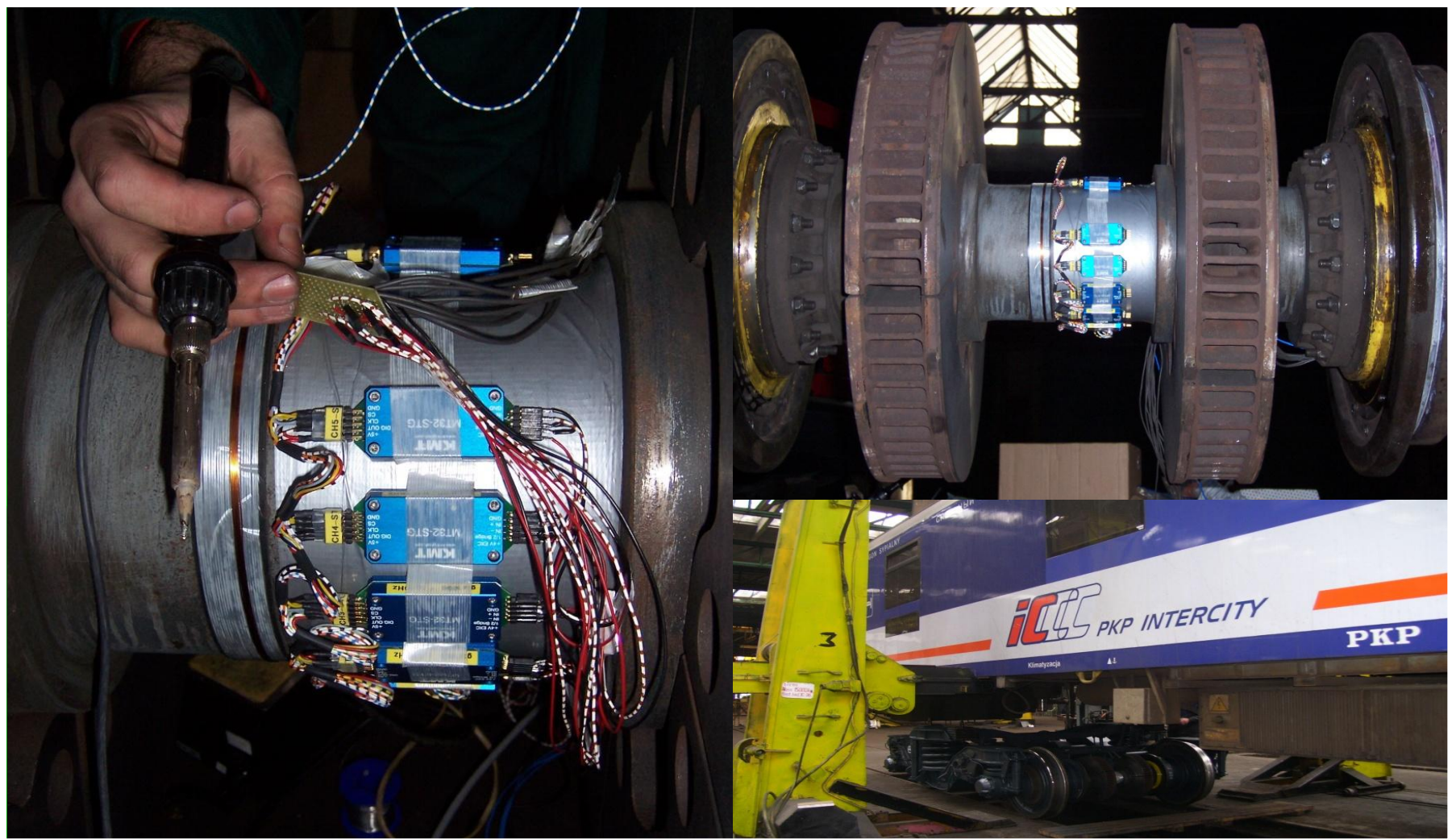

# Telemetry Application Examples

## MT32-Railway

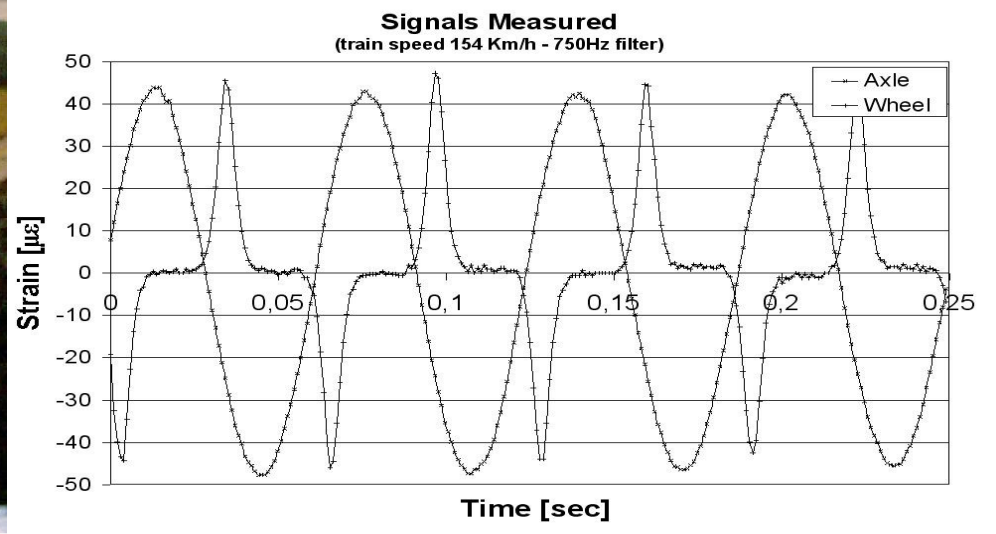
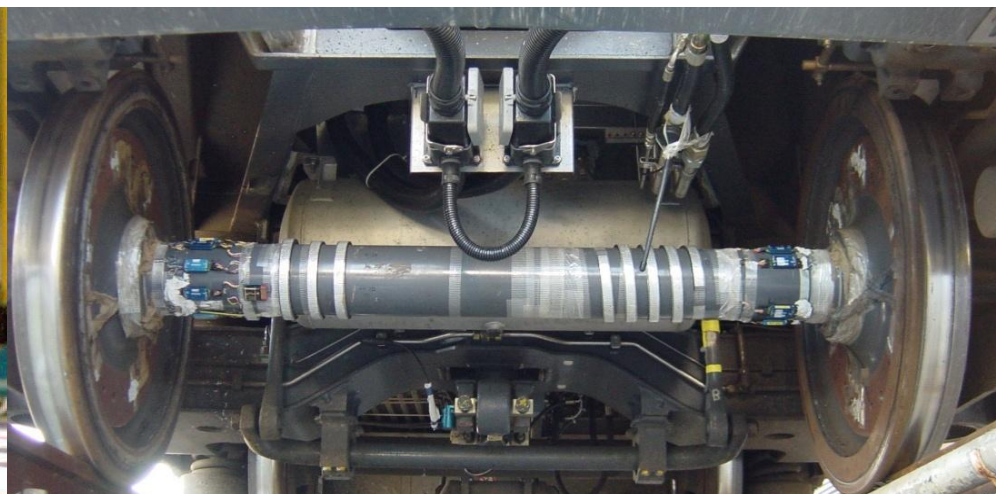
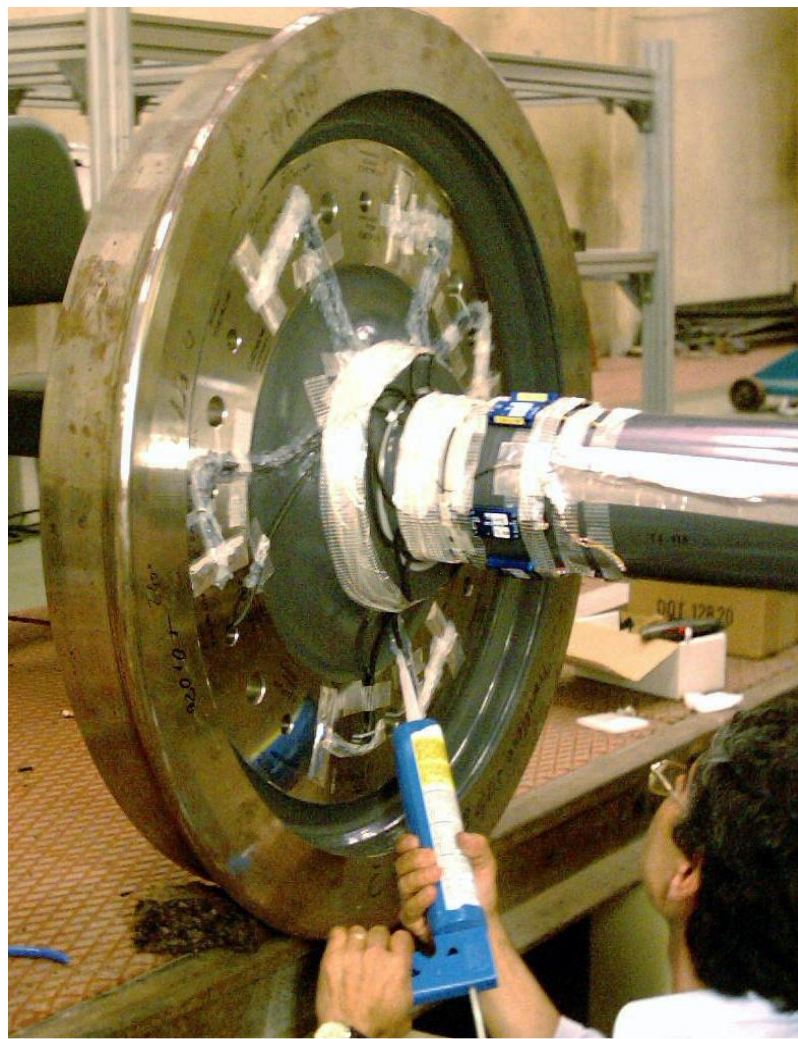

# Telemetry Application Examples

## MT32-Railway

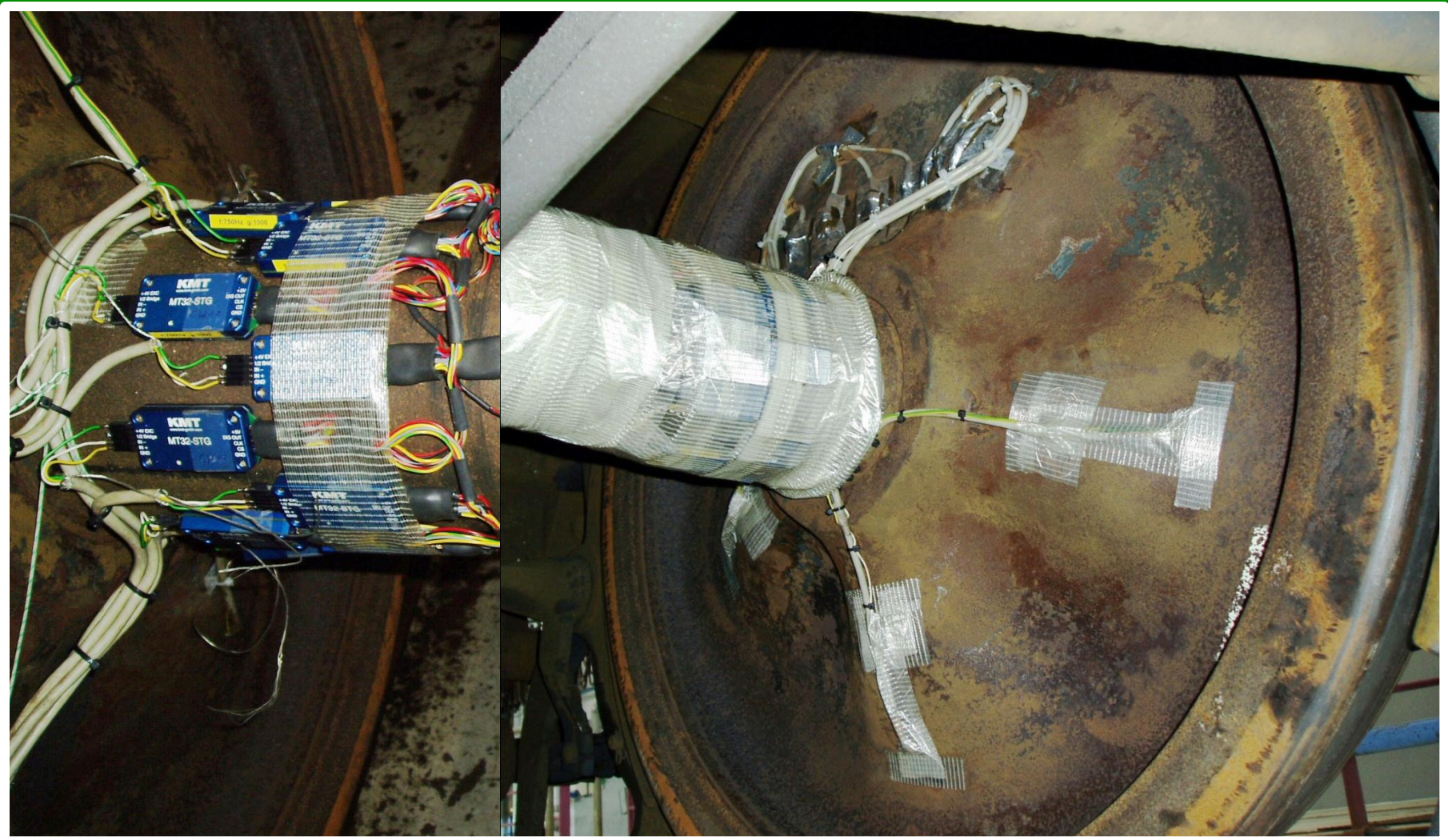

# Telemetry Application Examples

## MT32-Railway

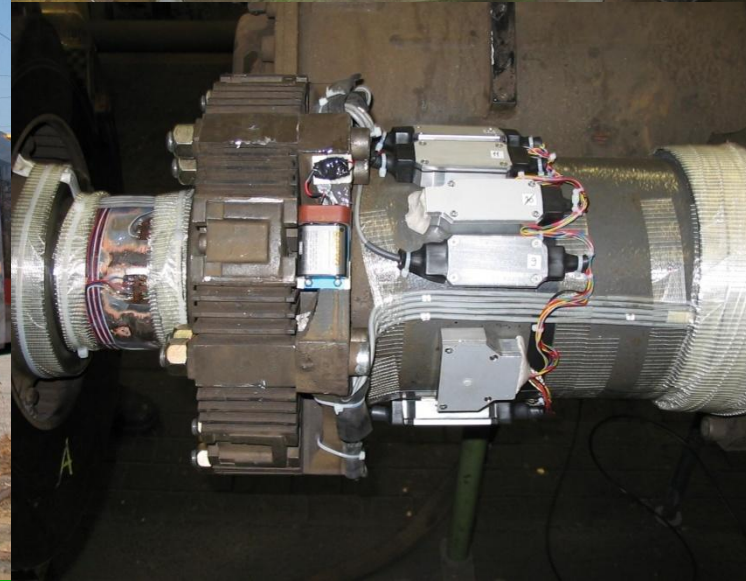

# Telemetry Application Examples

## MT32-Railway

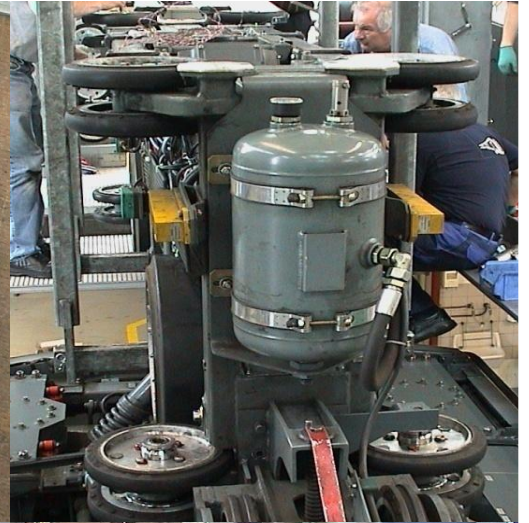

# Telemetry Application Examples

## MT32-Railway

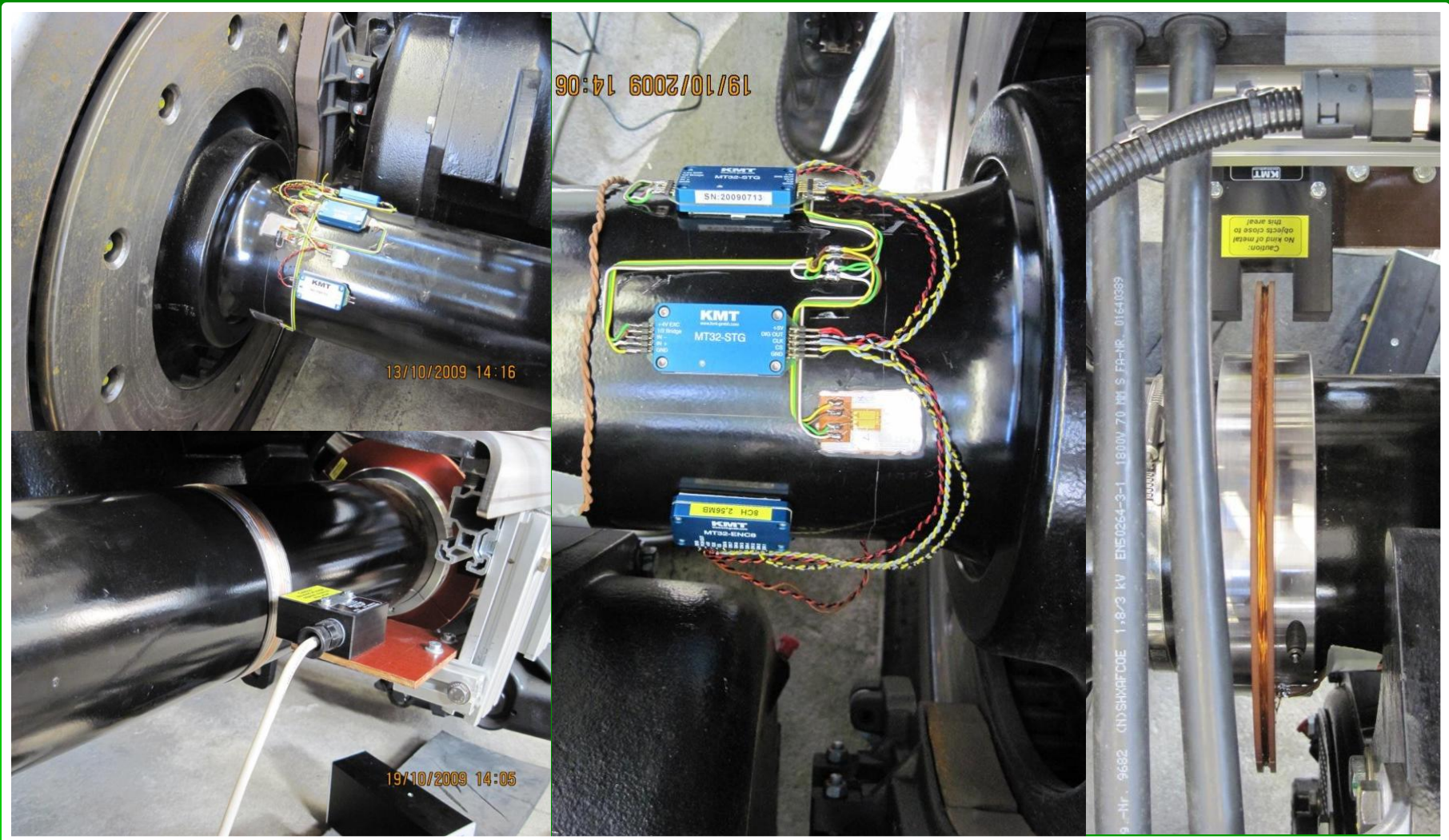

# Telemetry Application Examples

## MT32-Railway

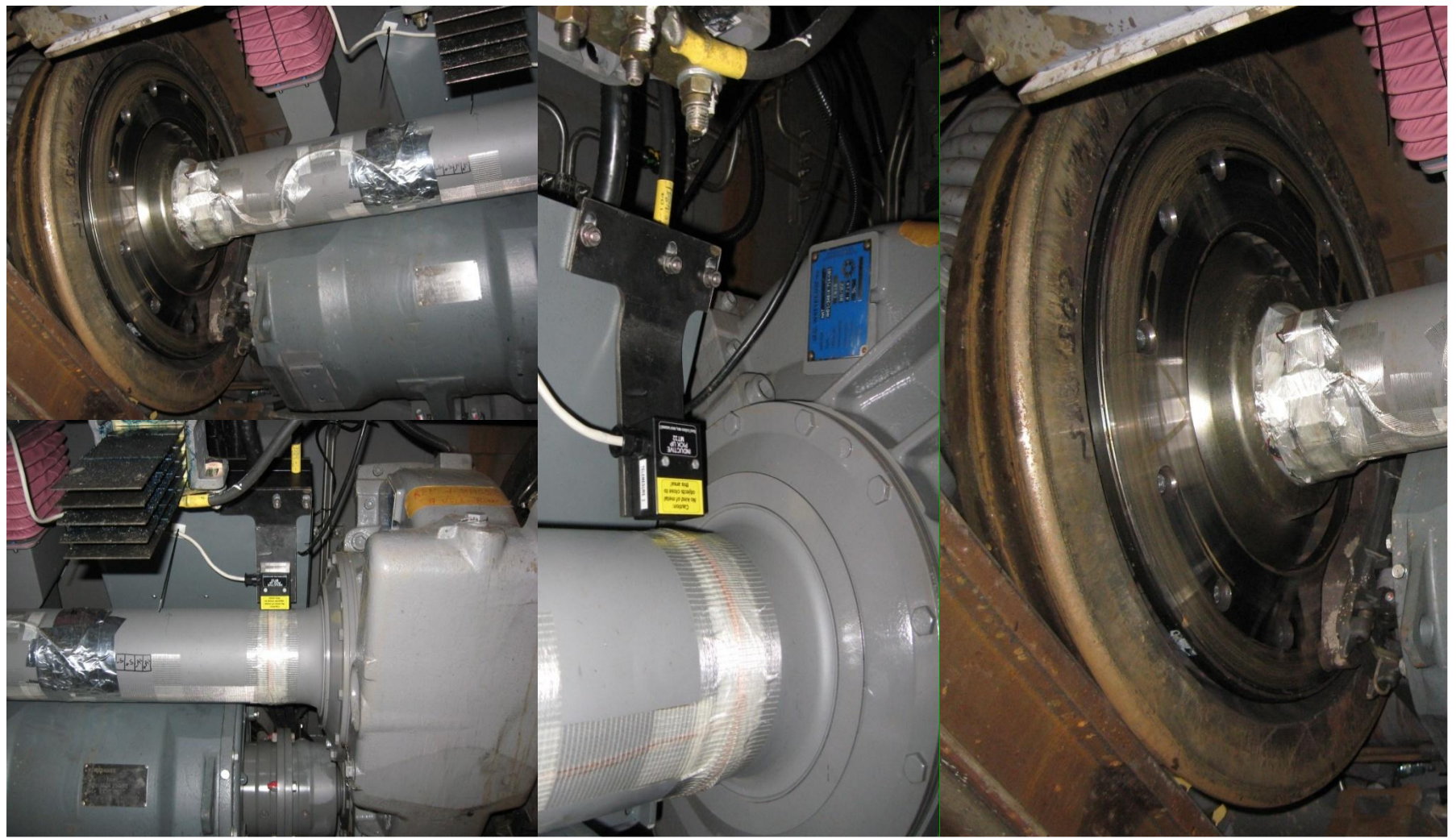



# Telemetry Application Examples

## MT32-Railway

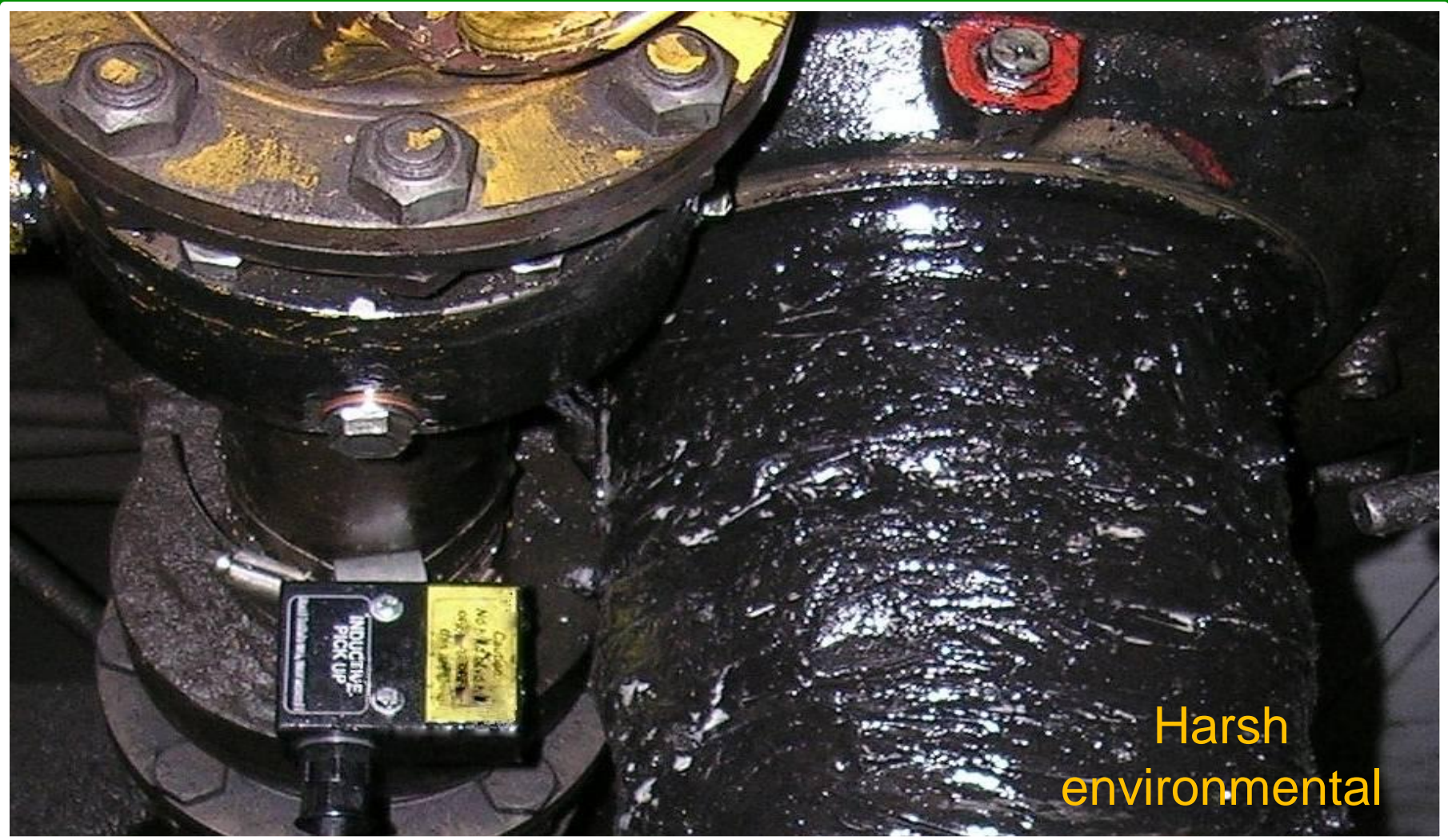

# Telemetry Application Examples

## MT32-Railway



# Telemetry Application Examples

## MT32-Railway

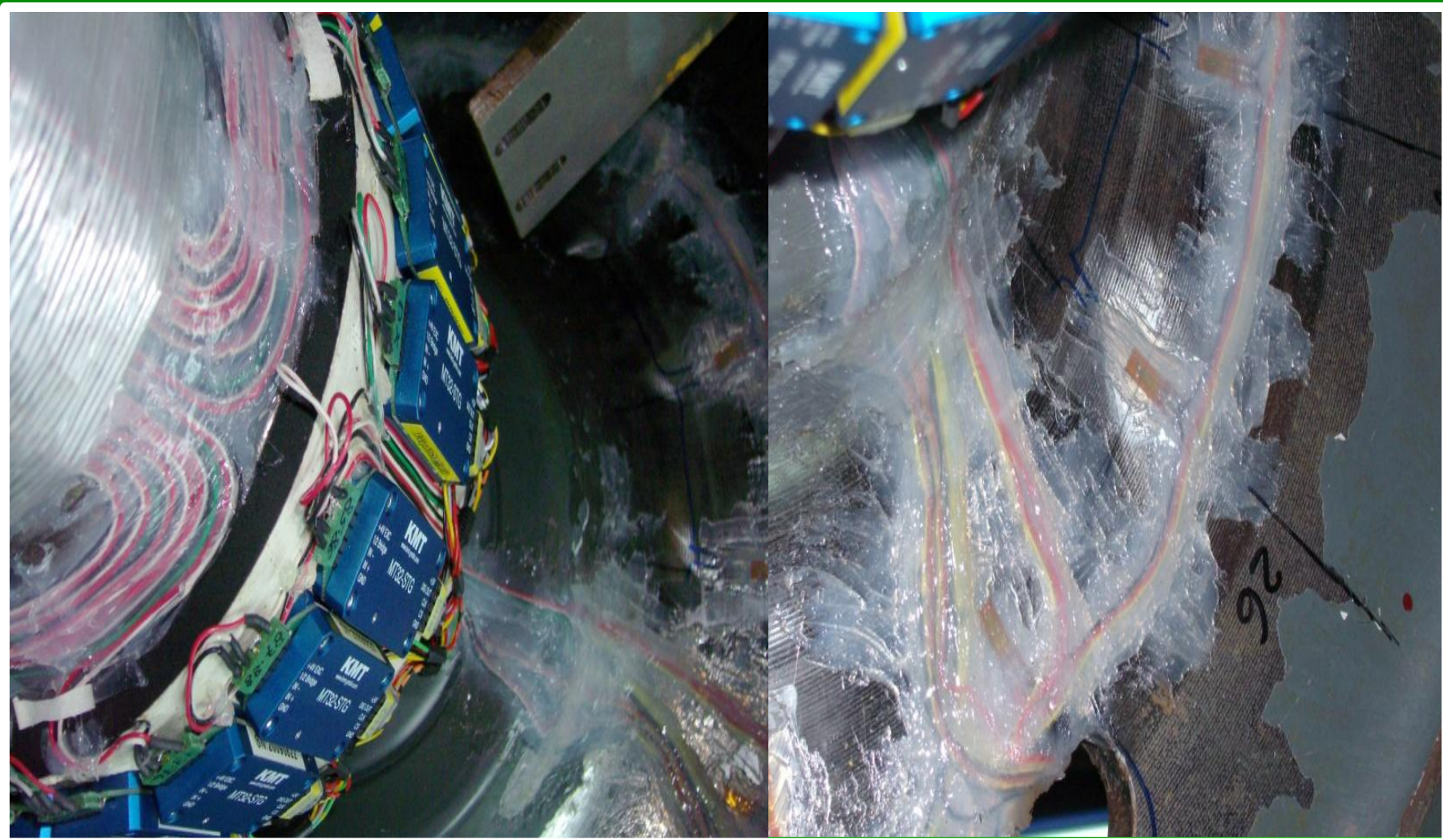

# Telemetry Application Examples

## MT32-Railway

Special customised solutions

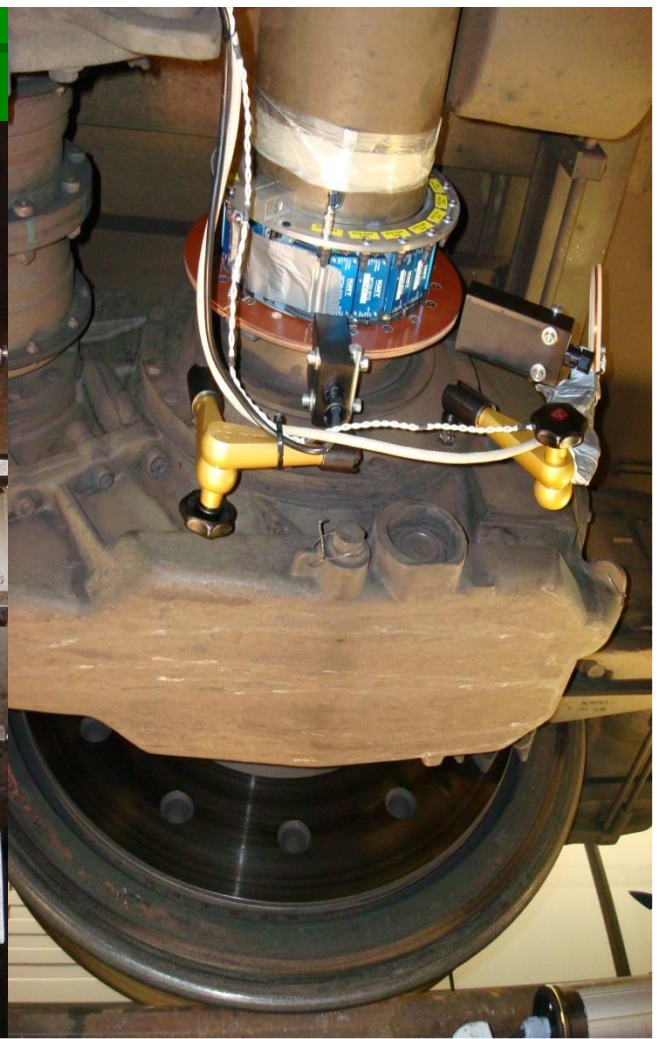
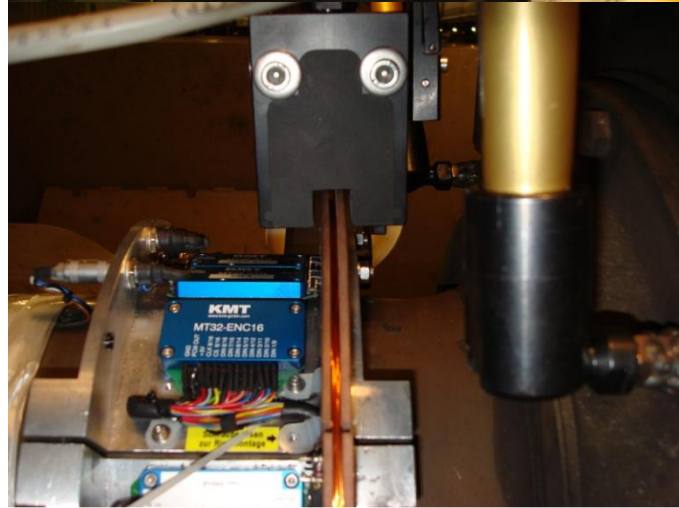

# Telemetry Application Examples

## MT32-Railway



Special customised solutions

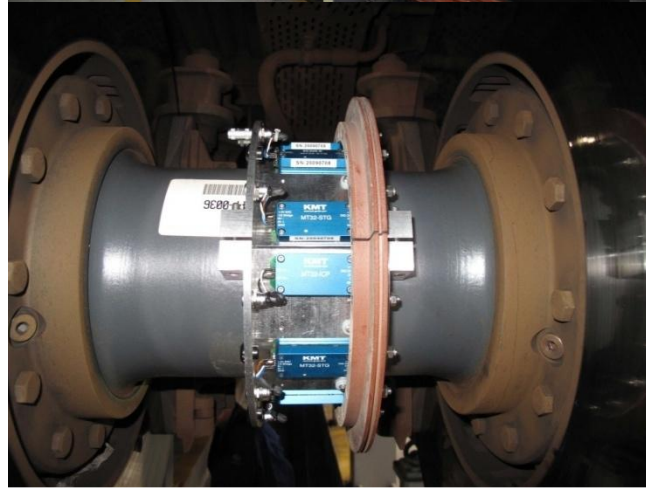

# Telemetry Application Examples

## MT32-Railway-Referencys

	ALSTOM – Railway, France, Germany		CFR - Railway Rumania		KNORR Brakes Germany
	BOMBARDIER France, Portugal, Germany		RWTH Aachen - University Germany		Interfleet Technology's Sweden
	CN - Railway Canada		MÁV - Railway Hungary		LMS Belgium
	Deutsche Bahn - Railway Germany		ÖBB - Railway Austrian		DeltaRail UK
	Indian Railway Institute		POLRAIL - Railway Poland		
	Nedtrain - Railway Netherlands		Siemens Germany		

# Thank you for your attention!

**KMT- Kraus Messtechnik GmbH**  
**Martin Kraus – Sales Manager**  
**Gewerbering 9**  
**D-83624 Otterfing - Germany**  
**Tel. +49-8024-48737**  
**Fax +49-8024-5532**  
**Email: [info@kmt-telemetry.com](mailto:info@kmt-telemetry.com)**  
**Web: [www.kmt-telemetry.com](http://www.kmt-telemetry.com)**